

GRID = 12" x 12"

PROPRIETARY AND CONFIDENTIAL
 THE INFORMATION CONTAINED IN THIS DRAWING IS THE
 SOLE PROPERTY OF INTECH TRAILERS. ANY REPRODUCTION
 IN PART OR AS A WHOLE WITHOUT THE WRITTEN PERMISSION
 OF INTECH TRAILERS IS PROHIBITED.

	NAME	DATE	<i>inTech Trailers</i>	
DRAWN	NJM	5/6/16	TEMPLATE WBTA8.5x20+4TA FLOORPLAN	
CHECKED				
ENG APPR.				
ALL DIMENSIONS ARE IN INCHES AND ARE NOMINAL. DIMENSIONS ON ACTUAL TRAILER MAY VARY FROM WHAT IS SHOWN ON PRINT BASED ON ACTUAL FRAMING AND TRAILER STRUCTURE. UNLESS NOTED AS CRITICAL			DWG. NO. WBTA8.5+4TA Trailer Assembly	REV. A
			SCALE: 1:36	SHEET 1 OF 4

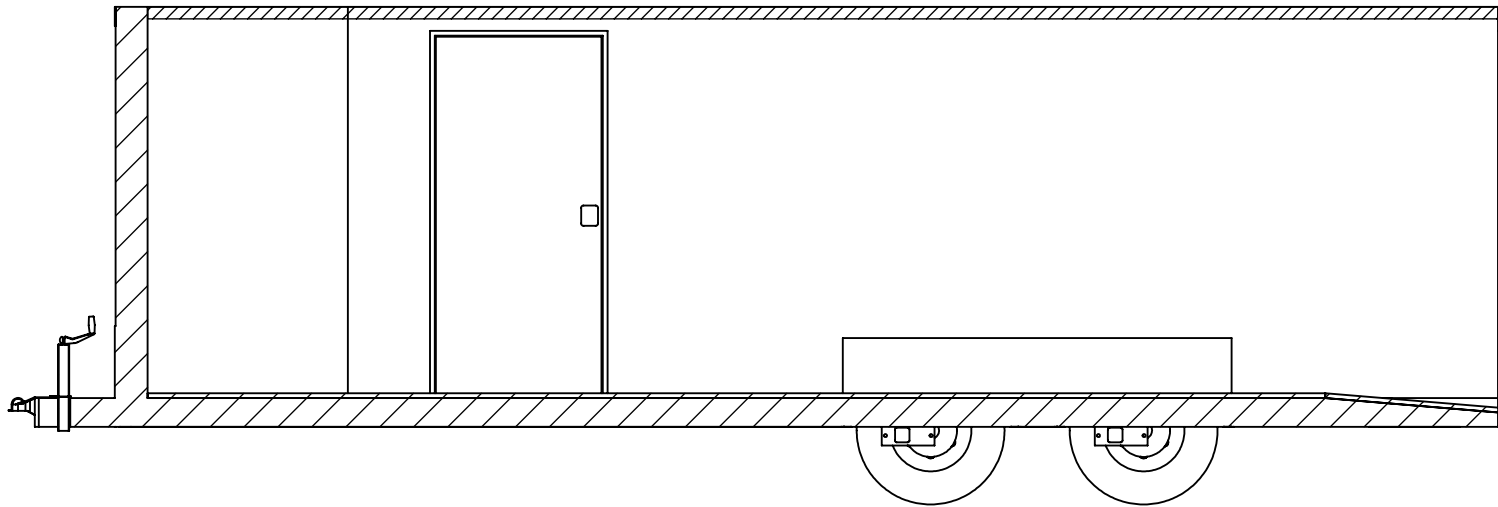

INTERIOR CURB SIDE

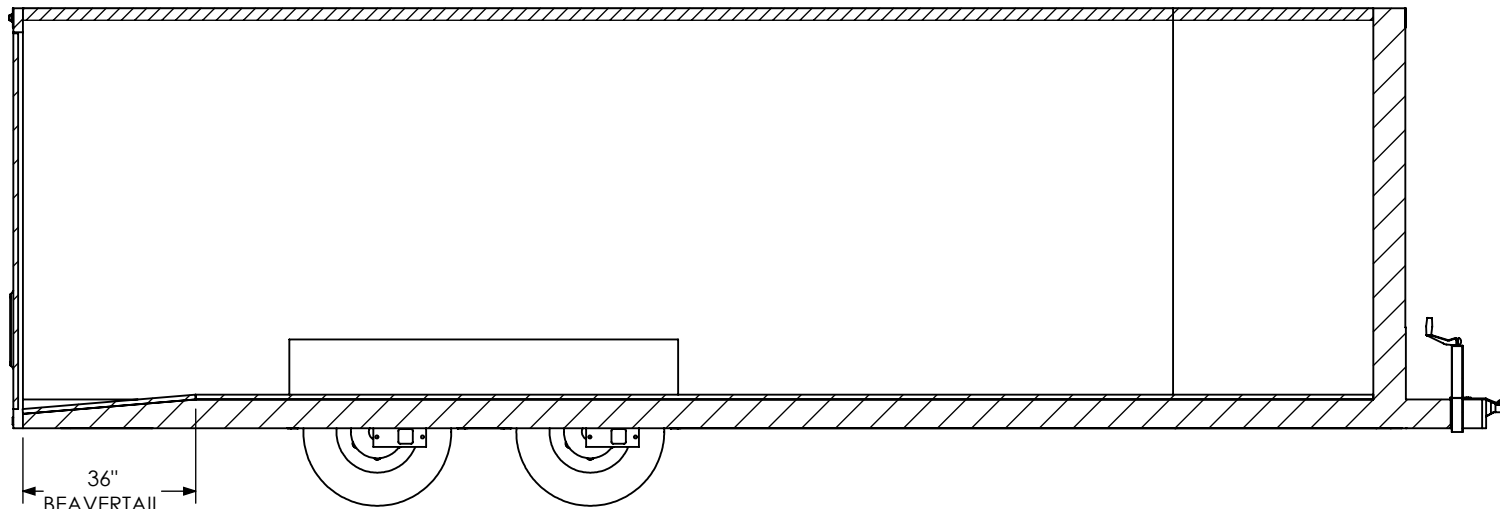

36"
BEAVERTAIL

INTERIOR ROAD SIDE

STANDARD:
- INTERIOR HEIGHT - 78"
- ENTRANCE DOOR - 36"

PROPRIETARY AND CONFIDENTIAL
THE INFORMATION CONTAINED IN THIS DRAWING IS THE SOLE PROPERTY OF INTECH TRAILERS. ANY REPRODUCTION IN PART OR AS A WHOLE WITHOUT THE WRITTEN PERMISSION OF INTECH TRAILERS IS PROHIBITED.

	NAME	DATE	<i>inTech Trailers</i> TEMPLATE WBTA8.5x20+4TA INTERIOR SIDES	
DRAWN	NJM	5/6/16		
CHECKED				
ENG APPR.				
ALL DIMENSIONS ARE IN INCHES AND ARE NOMINAL. DIMENSIONS ON ACTUAL TRAILER MAY VARY FROM WHAT IS SHOWN ON PRINT BASED ON ACTUAL FRAMING AND TRAILER STRUCTURE. UNLESS NOTED AS CRITICAL.			DWG. NO. WBTA8.5+4TA Trailer Assembly	REV. A
			SCALE: 1:40	SHEET 2 OF 4

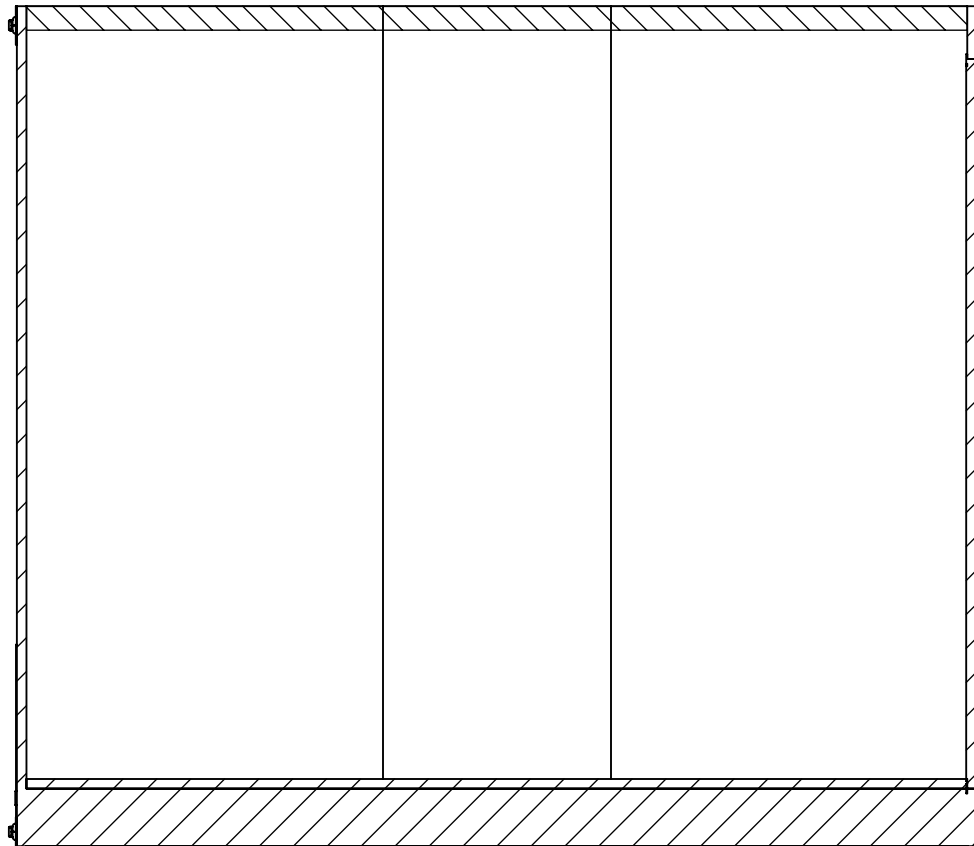

INTERIOR FRONT

	NAME	DATE	<i>inTech Trailers</i> TEMPLATE WBTA8.5x20+4TA INTERIOR FRONT	
DRAWN	NJM	5/6/16		
CHECKED				
ENG APPR.				
PROPRIETARY AND CONFIDENTIAL THE INFORMATION CONTAINED IN THIS DRAWING IS THE SOLE PROPERTY OF INTECH TRAILERS. ANY REPRODUCTION IN PART OR AS A WHOLE WITHOUT THE WRITTEN PERMISSION OF INTECH TRAILERS IS PROHIBITED.			ALL DIMENSIONS ARE IN INCHES AND ARE NOMINAL. DIMENSIONS ON ACTUAL TRAILER MAY VARY FROM WHAT IS SHOWN ON PRINT BASED ON ACTUAL FRAMING AND TRAILER STRUCTURE. UNLESS NOTED AS CRITICAL	
DWG. NO.		WBTA8.5+4TA Trailer Assembly		REV.
SCALE: 1:20				A
				SHEET 3 OF 4

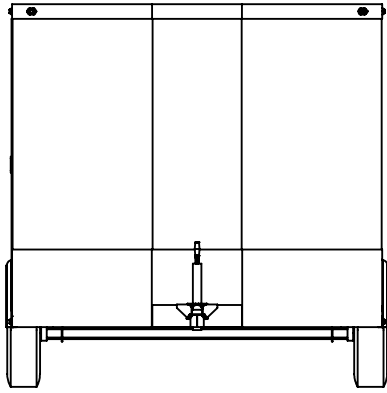

EXTERIOR FRONT

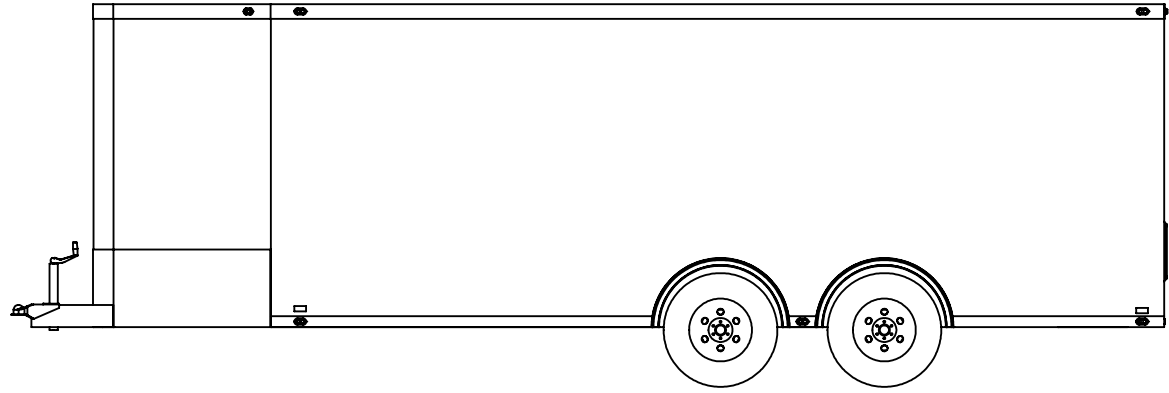

EXTERIOR ROAD SIDE

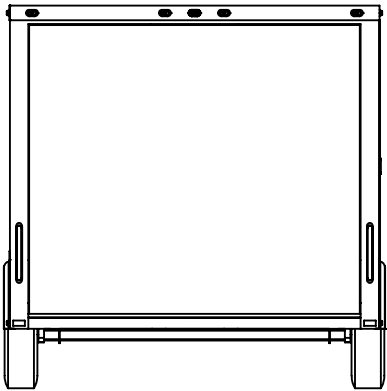

EXTERIOR REAR
RAMP DOOR STANDARD SIZE 90"W x 78"H

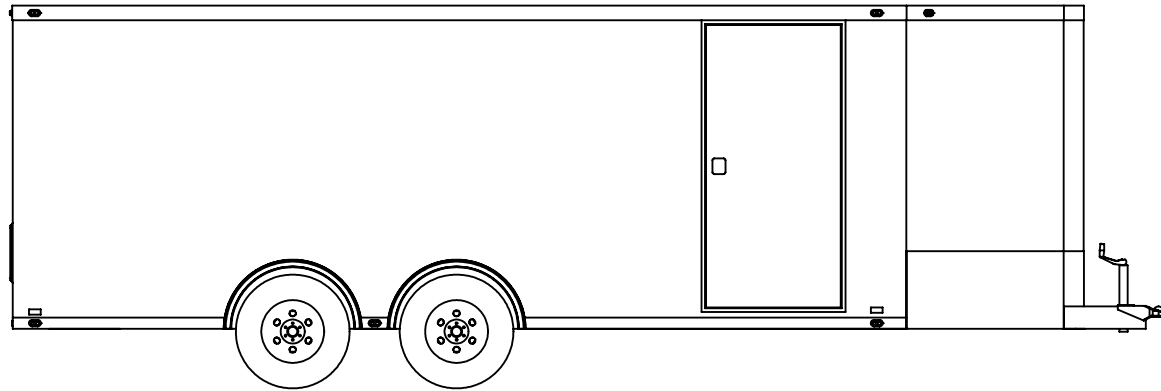

EXTERIOR CURB SIDE

	NAME	DATE	<i>inTech Trailers</i> TEMPLATE WBTA8.5x20+4TA EXTERIOR	
DRAWN	NJM	5/6/16		
CHECKED				
ENG APPR.				
<small>ALL DIMENSIONS ARE IN INCHES AND ARE NOMINAL. DIMENSIONS ON ACTUAL TRAILER MAY VARY FROM WHAT IS SHOWN ON PRINT BASED ON ACTUAL FRAMING AND TRAILER STRUCTURE. UNLESS NOTED AS CRITICAL</small>			DWG. NO.	REV.
			WBTA8.5+4TA Trailer Assembly	A
			SCALE: 1:52	SHEET 4 OF 4

PROPRIETARY AND CONFIDENTIAL
THE INFORMATION CONTAINED IN THIS DRAWING IS THE SOLE PROPERTY OF INTECH TRAILERS. ANY REPRODUCTION IN PART OR AS A WHOLE WITHOUT THE WRITTEN PERMISSION OF INTECH TRAILERS IS PROHIBITED.