

GRID = 12" x 12"

PROPRIETARY AND CONFIDENTIAL
 THE INFORMATION CONTAINED IN THIS DRAWING IS THE
 SOLE PROPERTY OF INTECH TRAILERS. ANY REPRODUCTION
 IN PART OR AS A WHOLE WITHOUT THE WRITTEN PERMISSION
 OF INTECH TRAILERS IS PROHIBITED.

	NAME	DATE	<i>inTech Trailers</i> TEMPLATE WBGA8.5x32TA FLOORPLAN	
DRAWN	NJM	5/18/16		
CHECKED				
ENG APPR.				
ALL DIMENSIONS ARE IN INCHES AND ARE NOMINAL. DIMENSIONS ON ACTUAL TRAILER MAY VARY FROM WHAT IS SHOWN ON PRINT BASED ON ACTUAL FRAMING AND TRAILER STRUCTURE. UNLESS NOTED AS CRITICAL			DWG. NO. BGA8.5 TA Trailer Assembly	REV. A
			SCALE: 1:42	SHEET 1 OF 4

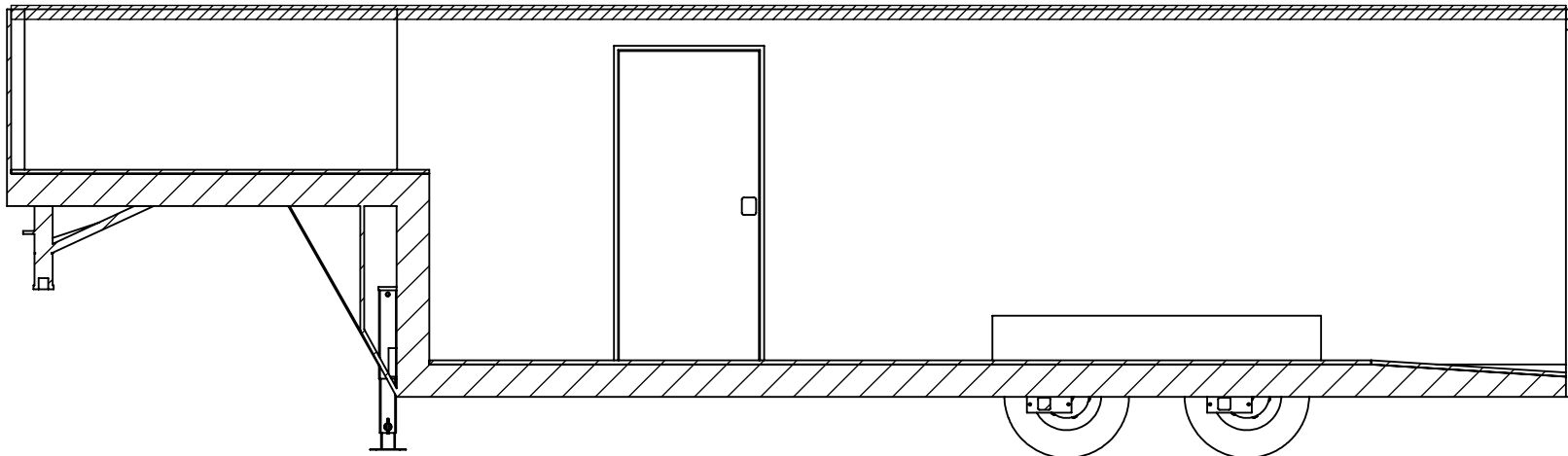

INTERIOR CURB SIDE

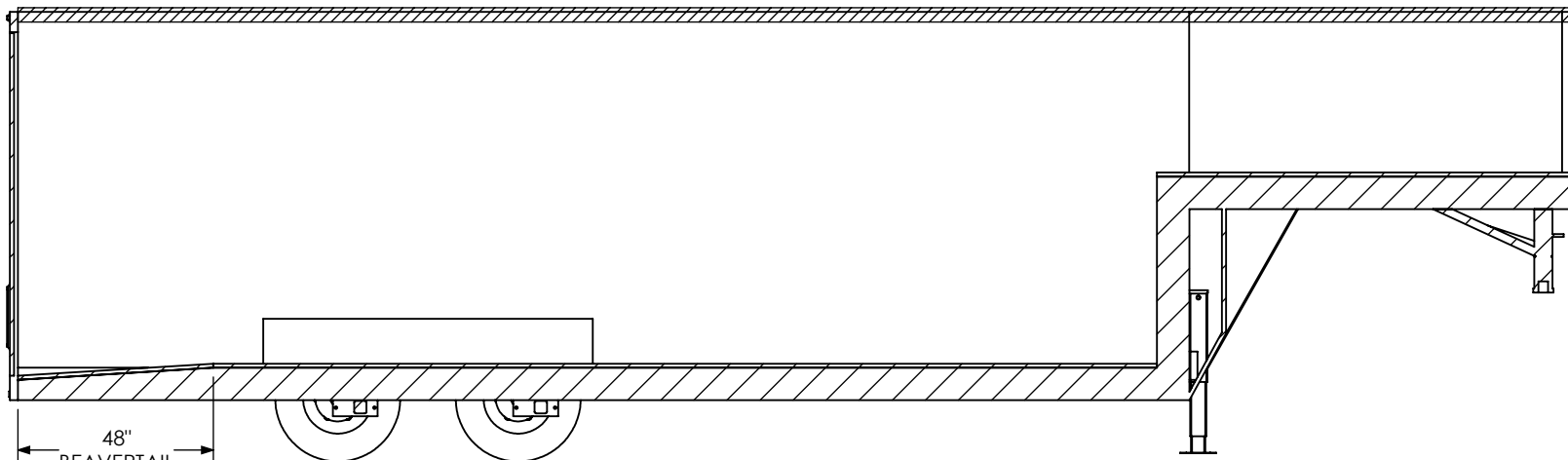

INTERIOR ROAD SIDE

48"
BEAVERTAIL

STANDARD:
- INTERIOR HEIGHT - 84"
- ENTRANCE DOOR - 36"

PROPRIETARY AND CONFIDENTIAL
THE INFORMATION CONTAINED IN THIS DRAWING IS THE SOLE PROPERTY OF INTECH TRAILERS. ANY REPRODUCTION IN PART OR AS A WHOLE WITHOUT THE WRITTEN PERMISSION OF INTECH TRAILERS IS PROHIBITED.

	NAME	DATE	<i>inTech Trailers</i>	
DRAWN	NJM	5/18/16	TEMPLATE WGA8.5x32TA INTERIOR SIDES	
CHECKED				
ENG APPR.				
<small>ALL DIMENSIONS ARE IN INCHES AND ARE NOMINAL. DIMENSIONS ON ACTUAL TRAILER MAY VARY FROM WHAT IS SHOWN ON PRINT BASED ON ACTUAL FRAMING AND TRAILER STRUCTURE. UNLESS NOTED AS CRITICAL.</small>			DWG. NO. BGA8.5 TA Trailer Assembly	REV. A
SCALE: 1:46			SHEET 2 OF 4	

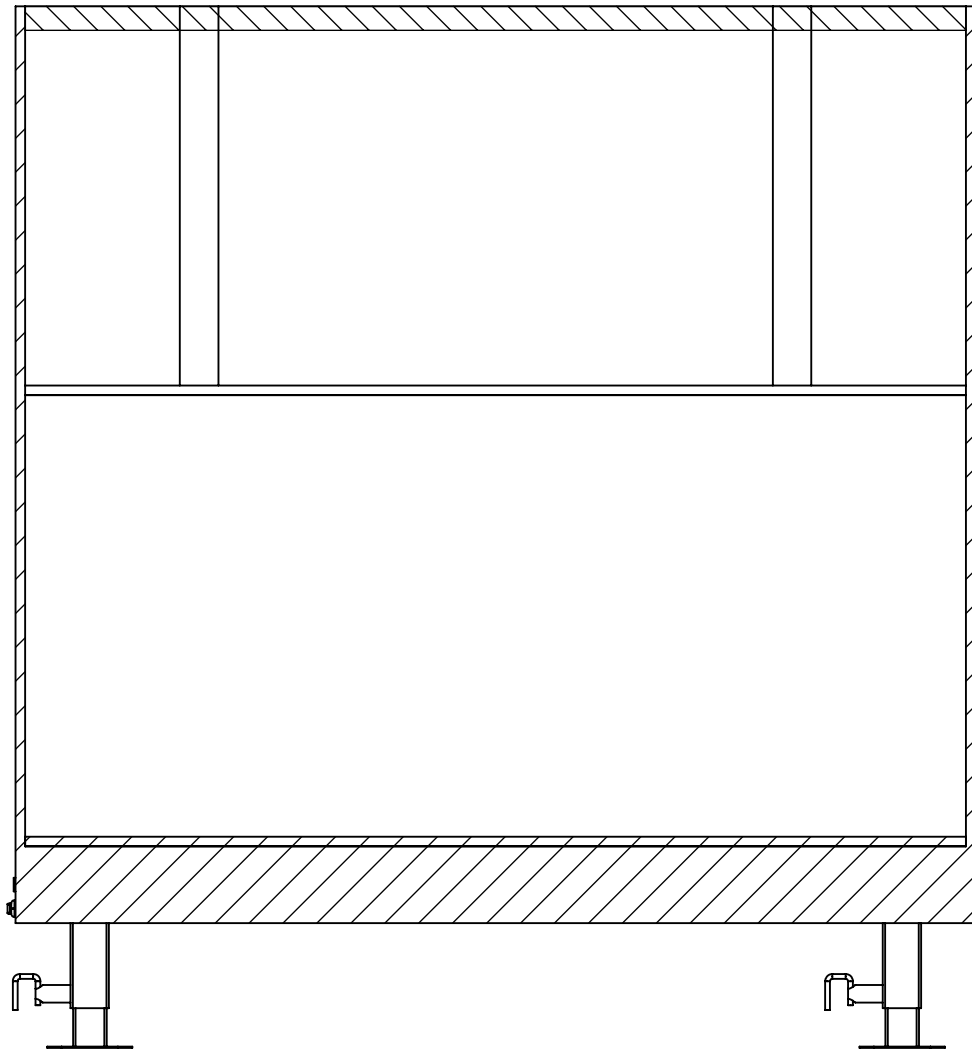

INTERIOR FRONT

	NAME	DATE	<i>inTech Trailers</i> TEMPLATE WGA8.5x32TA INTERIOR FRONT	
DRAWN	NJM	5/18/16		
CHECKED				
ENG APPR.				
ALL DIMENSIONS ARE IN INCHES AND ARE NOMINAL. DIMENSIONS ON ACTUAL TRAILER MAY VARY FROM WHAT IS SHOWN ON PRINT BASED ON ACTUAL FRAMING AND TRAILER STRUCTURE. UNLESS NOTED AS CRITICAL			DWG. NO.	REV.
			BGA8.5 TA Trailer Assembly	A
			SCALE: 1:20	SHEET 3 OF 4

PROPRIETARY AND CONFIDENTIAL
 THE INFORMATION CONTAINED IN THIS DRAWING IS THE
 SOLE PROPERTY OF INTECH TRAILERS. ANY REPRODUCTION
 IN PART OR AS A WHOLE WITHOUT THE WRITTEN PERMISSION
 OF INTECH TRAILERS IS PROHIBITED.

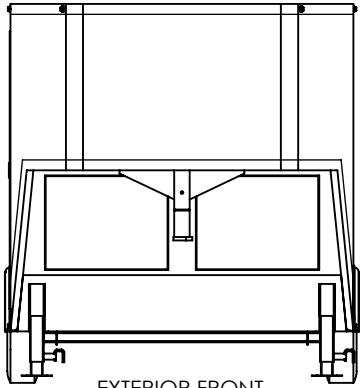

EXTERIOR FRONT

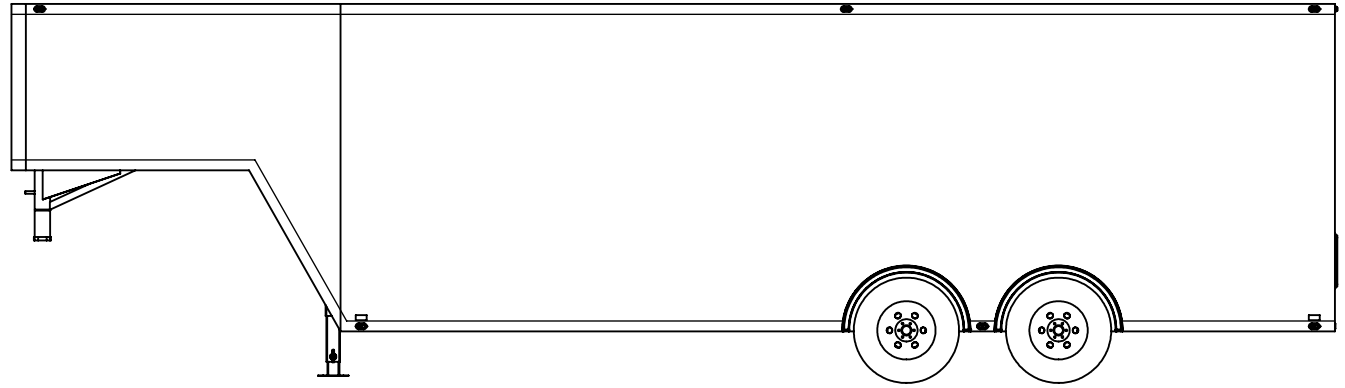

EXTERIOR ROAD SIDE

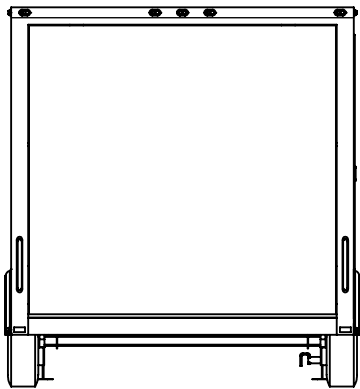

EXTERIOR REAR
RAMP DOOR STANDARD SIZE 90"W x 84"H

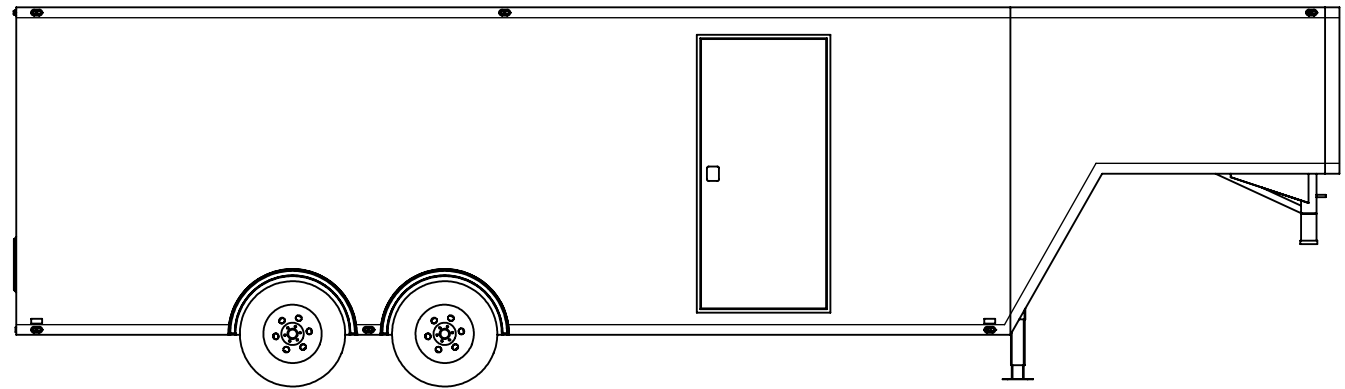

EXTERIOR CURB SIDE

	NAME	DATE	<i>inTech Trailers</i> TEMPLATE WGA8.5x32TA EXTERIOR	
DRAWN	NJM	5/18/16		
CHECKED				
ENG APPR.				
ALL DIMENSIONS ARE IN INCHES AND ARE NOMINAL. DIMENSIONS ON ACTUAL TRAILER MAY VARY FROM WHAT IS SHOWN ON PRINT BASED ON ACTUAL FRAMING AND TRAILER STRUCTURE. UNLESS NOTED AS CRITICAL			DWG. NO.	REV.
			BGA8.5 TA Trailer Assembly	
			SCALE: 1:56	SHEET 4 OF 4

PROPRIETARY AND CONFIDENTIAL
 THE INFORMATION CONTAINED IN THIS DRAWING IS THE
 SOLE PROPERTY OF INTECH TRAILERS. ANY REPRODUCTION
 IN PART OR AS A WHOLE WITHOUT THE WRITTEN PERMISSION
 OF INTECH TRAILERS IS PROHIBITED.