

GRID = 12" x 12"

**PROPRIETARY AND CONFIDENTIAL**  
 THE INFORMATION CONTAINED IN THIS DRAWING IS THE  
 SOLE PROPERTY OF INTECH TRAILERS. ANY REPRODUCTION  
 IN PART OR AS A WHOLE WITHOUT THE WRITTEN PERMISSION  
 OF INTECH TRAILERS IS PROHIBITED.

	NAME	DATE	<b><i>inTech Trailers</i></b>  TEMPLATE WGA8.5x38TA FLOORPLAN	
DRAWN	NJM	5/18/16		
CHECKED				
ENG APPR.				
ALL DIMENSIONS ARE IN INCHES AND ARE NOMINAL. DIMENSIONS ON ACTUAL TRAILER MAY VARY FROM WHAT IS SHOWN ON PRINT BASED ON ACTUAL FRAMING AND TRAILER STRUCTURE. UNLESS NOTED AS CRITICAL			DWG. NO. BGA8.5 TA Trailer Assembly	REV. A
			SCALE: 1:48	SHEET 1 OF 4

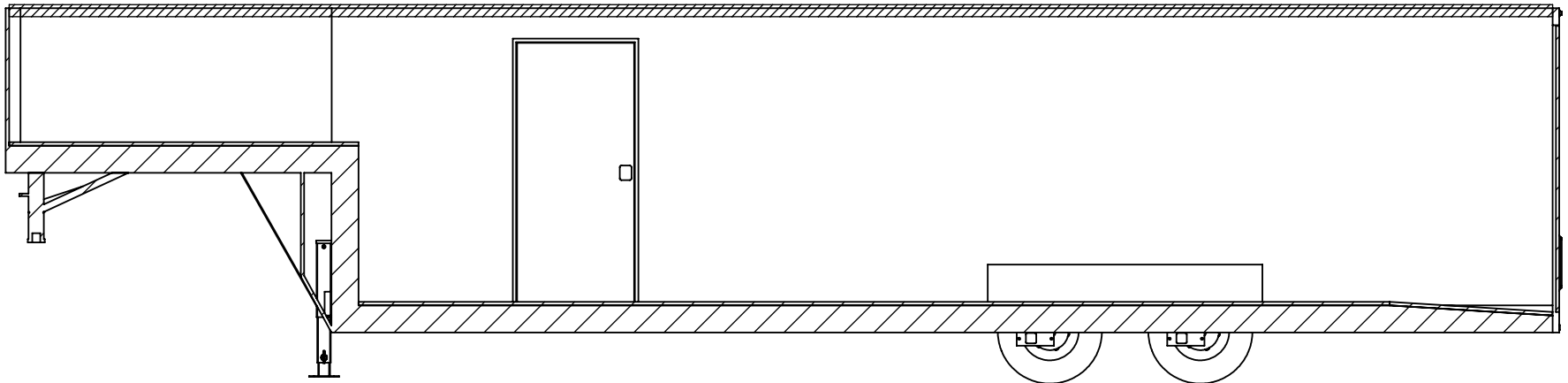

INTERIOR CURB SIDE

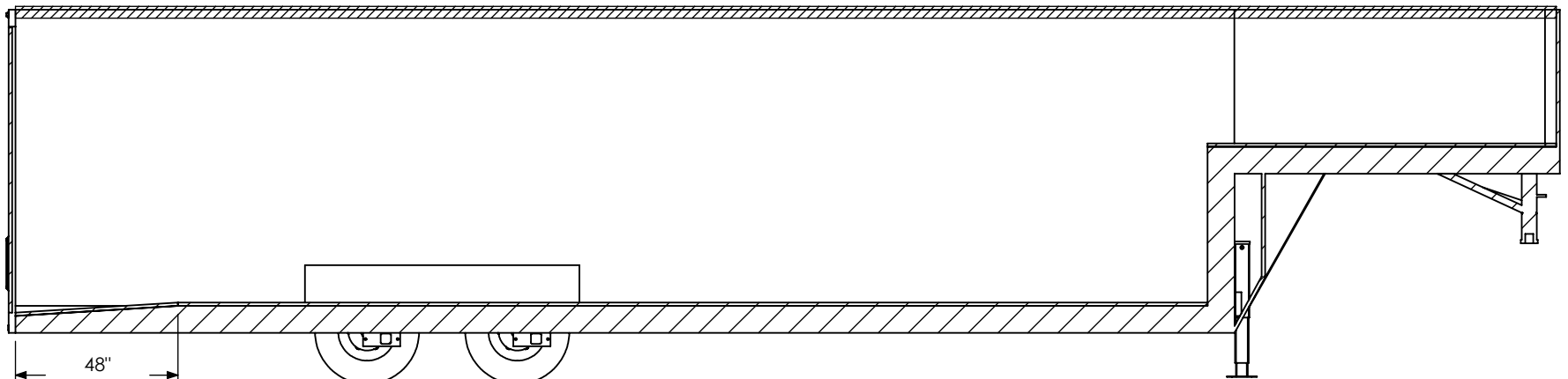

48"  
BEAVERTAIL

INTERIOR ROAD SIDE

STANDARD:  
- INTERIOR HEIGHT - 84"  
- ENTRANCE DOOR - 36"

**PROPRIETARY AND CONFIDENTIAL**  
THE INFORMATION CONTAINED IN THIS DRAWING IS THE SOLE PROPERTY OF INTECH TRAILERS. ANY REPRODUCTION IN PART OR AS A WHOLE WITHOUT THE WRITTEN PERMISSION OF INTECH TRAILERS IS PROHIBITED.

	NAME	DATE	<b><i>inTech Trailers</i></b>  TEMPLATE WGA8.5x38TA INTERIOR SIDES	
DRAWN	NJM	5/18/16		
CHECKED				
ENG APPR.				
ALL DIMENSIONS ARE IN INCHES AND ARE NOMINAL. DIMENSIONS ON ACTUAL TRAILER MAY VARY FROM WHAT IS SHOWN ON PRINT BASED ON ACTUAL FRAMING AND TRAILER STRUCTURE. UNLESS NOTED AS CRITICAL			DWG. NO. BGA8.5 TA Trailer Assembly	REV. A
			SCALE: 1:50	SHEET 2 OF 4

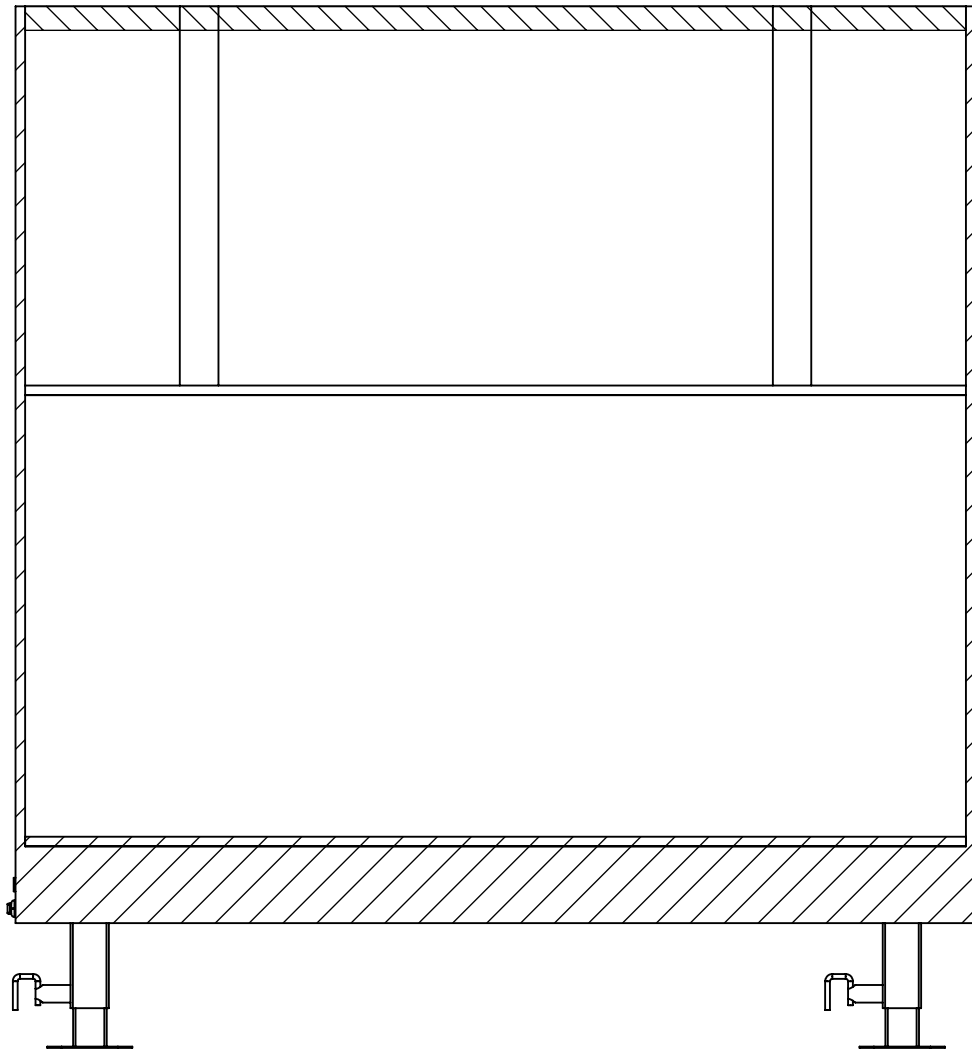

INTERIOR FRONT

	NAME	DATE	<b><i>inTech Trailers</i></b>  TEMPLATE WGA8.5x38TA INTERIOR FRONT	
DRAWN	NJM	5/18/16		
CHECKED				
ENG APPR.				
ALL DIMENSIONS ARE IN INCHES AND ARE NOMINAL. DIMENSIONS ON ACTUAL TRAILER MAY VARY FROM WHAT IS SHOWN ON PRINT BASED ON ACTUAL FRAMING AND TRAILER STRUCTURE. UNLESS NOTED AS CRITICAL			DWG. NO.	REV.
			BGA8.5 TA Trailer Assembly	A
			SCALE: 1:20	SHEET 3 OF 4

**PROPRIETARY AND CONFIDENTIAL**  
 THE INFORMATION CONTAINED IN THIS DRAWING IS THE  
 SOLE PROPERTY OF INTECH TRAILERS. ANY REPRODUCTION  
 IN PART OR AS A WHOLE WITHOUT THE WRITTEN PERMISSION  
 OF INTECH TRAILERS IS PROHIBITED.

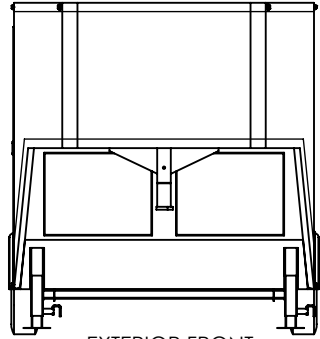

EXTERIOR FRONT

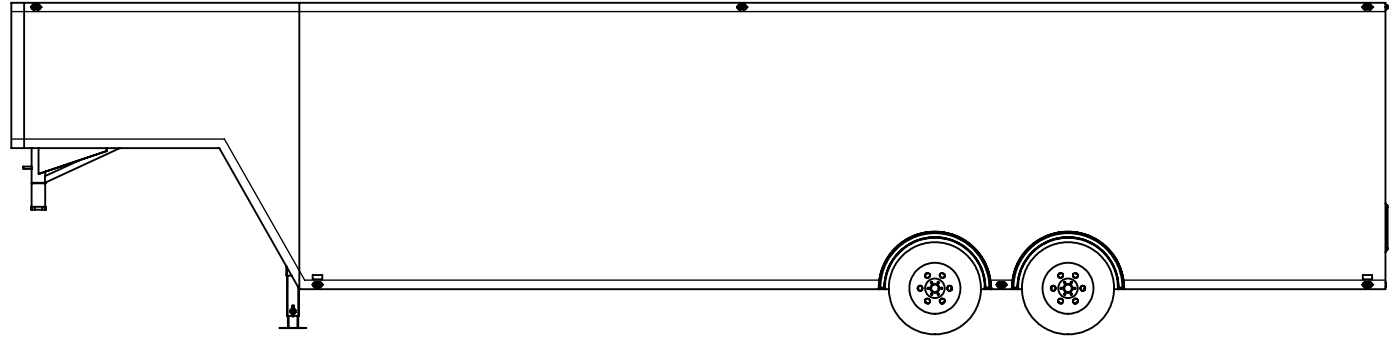

EXTERIOR ROAD SIDE

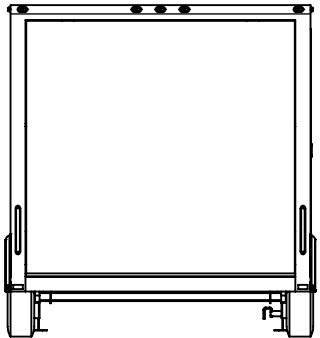

EXTERIOR REAR  
RAMP DOOR STANDARD SIZE 90"W x 84"H

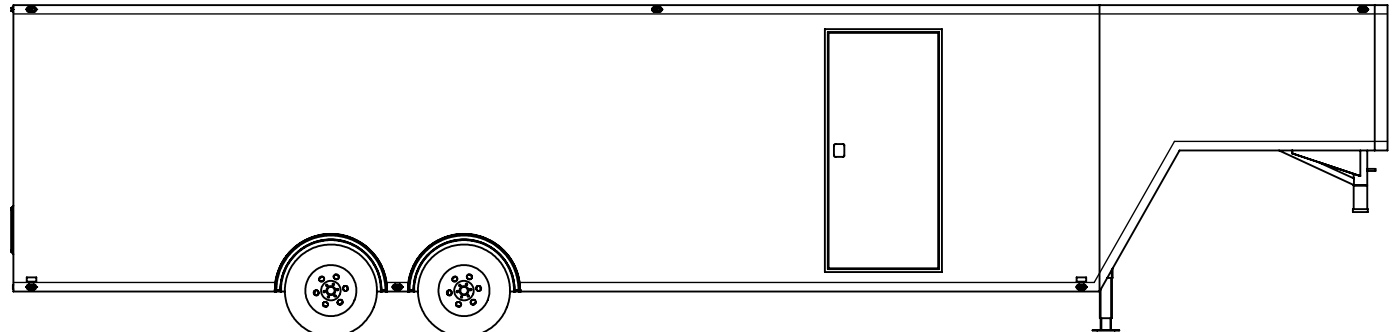

EXTERIOR CURB SIDE

	NAME	DATE	<b><i>inTech Trailers</i></b>  TEMPLATE WGA8.5x38TA EXTERIOR	
DRAWN	NJM	5/18/16		
CHECKED				
ENG APPR.				
<p>ALL DIMENSIONS ARE IN INCHES AND ARE NOMINAL. DIMENSIONS ON ACTUAL TRAILER MAY VARY FROM WHAT IS SHOWN ON PRINT BASED ON ACTUAL FRAMING AND TRAILER STRUCTURE. UNLESS NOTED AS CRITICAL</p>			DWG. NO.	REV.
			BGA8.5 TA Trailer Assembly	A
SCALE: 1:64			SHEET 4 OF 4	

**PROPRIETARY AND CONFIDENTIAL**  
THE INFORMATION CONTAINED IN THIS DRAWING IS THE SOLE PROPERTY OF INTECH TRAILERS. ANY REPRODUCTION IN PART OR AS A WHOLE WITHOUT THE WRITTEN PERMISSION OF INTECH TRAILERS IS PROHIBITED.